

LED LAMPS

2 year warranty

June 2010

LED SPOTLAMP

42 mm **MR16**



12 Volt 175-008

	Base	Color	Power	Lumen	Kelvin	Angle	Compare with
175-008	MR16	warm white	1,5W	40	3200	25°	10W

HIGH POWER LED SPOTLAMP

45 mm **MR16**



12 Volt 175-001(W)
175-028(WW)

	Base	Color	Power	Lumen	Kelvin	Angle	Compare with
175-001	MR16	white	3W	90	6000	30°	15W
175-028	MR16	warm white	3W	70	2800	30°	15W

HIGH POWER LED SPOTLAMP

41/48 mm **MR16**



12 Volt 175-011(W)
175-038(WW)

	Base	Color	Power	Lumen	Kelvin	Angle	Compare with
175-011	MR16	white	5W	225	5500	45°	25W
175-038	MR16	warm white	5W	175	2800	45°	25W

LED SPOTLAMP

50 mm **GU10**



230 Volt 175-018

	Base	Color	Power	Lumen	Kelvin	Angle	Compare with
175-018	GU10	warm white	1,5W	40	3200	25°	10W

HIGH POWER LED SPOTLAMP

63 mm **GU10**



230 Volt 175-108

	Base	Color	Power	Lumen	Kelvin	Angle	Compare with
175-108	GU10	warm white	3W	80	2800	30°	15W

HIGH POWER LED SPOTLAMP

66/74 mm **GU10**



230 Volt 175-061(W)
175-078(WW)

	Base	Color	Power	Lumen	Kelvin	Angle	Compare with
175-061	GU10	white	5W	225	5500	45°	28W
175-078	GU10	warm white	5W	175	2800	45°	28W

HIGH POWER LED SPOTLAMP

42/49 mm **PAR20**



230 Volt 175-021(W)
175-048(WW)

	Base	Color	Power	Lumen	Kelvin	Angle	Compare with
175-021	E27	white	5W	225	5500	45°	28W
175-048	E27	warm white	5W	175	2800	45°	28W

HIGH POWER LED SPOTLAMP

100 mm **PAR20**

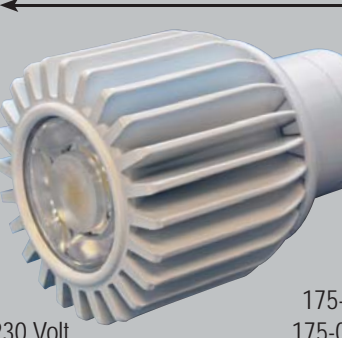

230 Volt 175-051(W)
175-088(WW)

	Base	Color	Power	Lumen	Kelvin	Angle	Compare with
175-051	E27	white	10W	550	5000	60°	60W
175-088	E27	warm white	10W	450	3000	60°	60W

HIGH POWER LED SPOTLAMP

100 mm **PAR30**



230 Volt 175-228

	Base	Color	Power	Lumen	Kelvin	Angle	Compare with
175-228	E27	warm white	13W	580	3100	30°	65W

LED AR111 WITH DRIVER

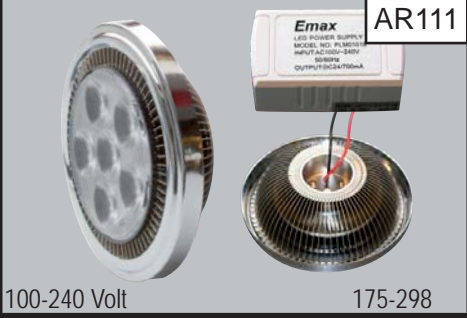

	Base	Color	Power	Lumen	Kelvin	Angle	Compare with
175-298	N.A.	warm white	12W	750	3500	40°	70W

LED AR111 RETRO FIT



	Base	Color	Power	Lumen	Kelvin	Angle	Compare with
175-268	N.A.	warm white	12W	600	3500	25°	50W
175-278	N.A.	warm white	12W	600	3500	40°	50W

LED PAR 38



	Base	Color	Power	Lumen	Kelvin	Angle	Compare with
175-211	E27	white	16W	620	6000	25°	80W
175-218	E27	warm white	16W	540	3500	25°	80W

LED P45

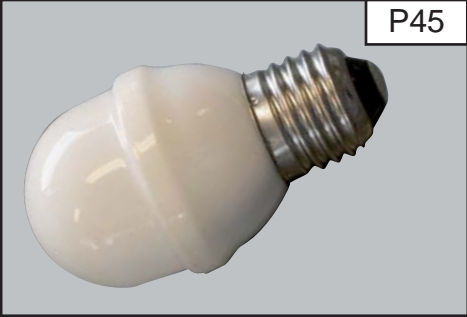

P45-9L-230V With 9 LED's and E27 base.
Under development.

LED A60

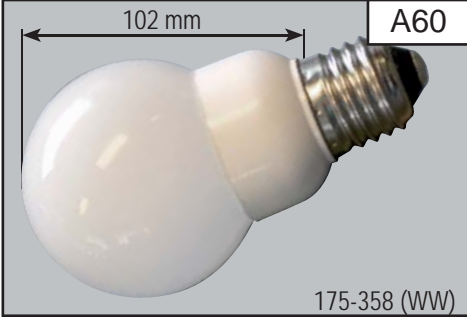

	Base	Color	Power	Lumen	Kelvin	Angle	Compare with
175-358	E27	warm white	1,35W	40	3000	276°	7W

LED A60

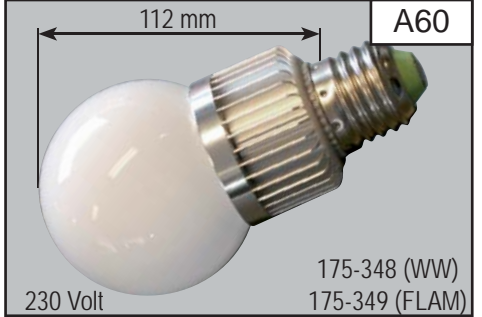

	Base	Color	Power	Lumen	Kelvin	Angle	Compare with
175-348	E27	warm white	3W	190	3000	276°	25W
175-349	E27	flame	3W	170	2500	276°	25W

HIGH POWER LED SPOTLAMP



	Base	Color	Power	Lumen	Kelvin	Angle	Compare with
175-031	GU10	white	3W	92	6000	30°	13W
175-068	GU10	warm white	3W	90	3000	30°	13W

HIGH POWER LED SPOTLAMP



	Base	Color	Power	Lumen	Kelvin	Angle	Compare with
175-00	MR16	RGBA	3W	-	-	38°	-

HIGH POWER LED SPOTLAMP

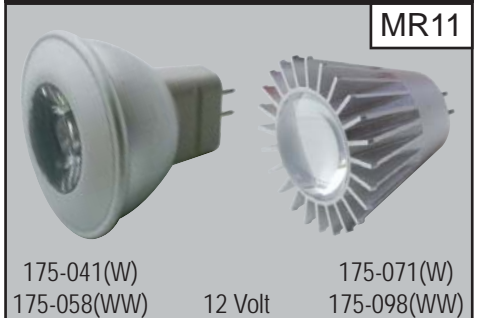

	Base	Color	Power	Lumen	Kelvin	Angle	Compare with
175-0-1	MR11	white	1W	48	6000	38°	10W
175-0-8	MR11	warm white	1W	40	3000	38°	10W

LED DECO LAMP

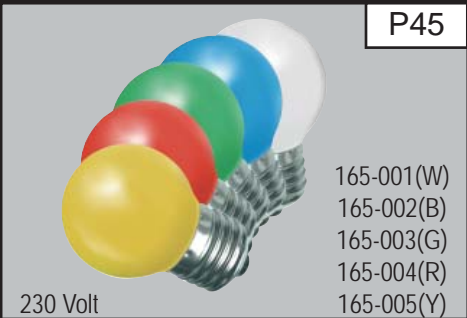

	Base	Color	Power	Lumen	Kelvin	Angle	Compare with
165-00	E27	RGBWY	1W	-	-	-	-

LED DECO LAMP HEAVY DUTY

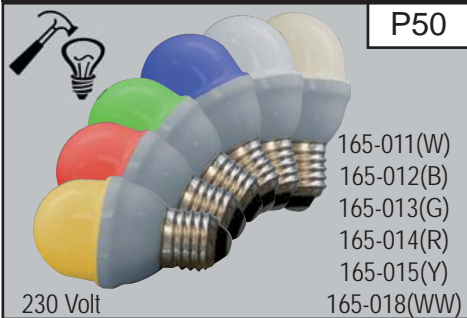

	Base	Color	Power	Lumen	Kelvin	Angle	Compare with
165-01	E27	WRGBY	1W	-	-	-	-

LED COLOR CHANGING LAMP

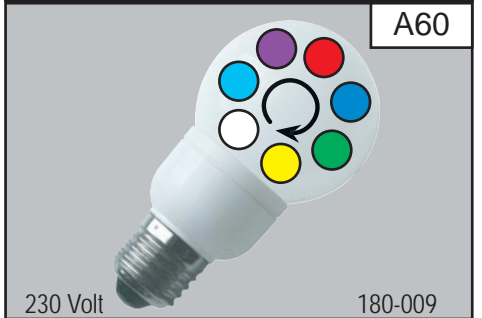

	Base	Color	Power	Lumen	Kelvin	Angle	Compare with
180-009	E27	changing	1W	-	-	-	-

LED SPOTLAMP RGB MASTER



180-020

RGB-MASTER 12 Volt 5 Watt RGB Master LED spotlamp with 30 cm wire with quick connector. Ø 50mm. Use with 4 wire cable 180-022 and remote control 180-023.

LED SPOTLAMP RGB SLAVE



180-021

RGB-SLAVE 12 Volt 5 Watt RGB Slave LED spotlamp with 30 cm wire with quick connector. Ø 50mm. Use with 4 wire cable 180-022 in combination with a RGB-Master.

4 WIRE CABLE / REMOTE CONTROL



180-023 (small)
180-024 (large)

RGB-Q-CON 4 Wire cable with quick connector for master or slave every 30 cm.
RGB-RC Remote control for LED Spotlamp RGB Single and Master. Available as small and large model.

LED SPOTLAMP RGB SINGLE



180-010

RGB-S-MR16F 12 Volt 5 Watt RGB LED spotlamp with MR16 base. Ø 50mm. Use with remote control 180-023.

LED SPOTLAMP RGB SINGLE



180-011

RGB-S-GU10F 230 Volt 5 Watt RGB LED spotlamp with GU10 base. Ø 50mm. Use with remote control 180-023.

LED SPOTLAMP RGB SINGLE



180-012

RGB-S-E27E 230 Volt 5 Watt RGB LED spotlamp with E27 base. Ø 50mm. Use with remote control 180-023.

LED TL TUBE



177-008

T8-2F-DF-WW 60 cm TL tube with 168 SMD LED's, aluminium housing and diffuse cover. Power 8 Watt, Lumen 500, color temperature 3000k.

LED TL TUBE



177-018

T8-4F-DF-WW 120 cm TL tube with 300 SMD LED's, aluminium housing and diffuse cover. Power 15 Watt, Lumen 900, color temperature 3000k.

LED TL TUBE



177-011

T8-4F-CL-W 120 cm TL tube with 315 SMD LED's, aluminium housing and clear cover. Power 18 Watt, Lumen ?, color temperature 4100k.

NOTICE MR16 12V LAMPS

Some electronic transformers require a minimum load to operate properly. With only a few lamps in a circuit, they may not meet the minimum load required for an electronic transformer. As a result the LED lamps may flash or may not work properly.

NOTICE LED TL TUBES

In most cases TL tubes are replaceable with LED TL tubes by removing the starter. In case this does not work connect both sides of the LED TL tube directly to 230 Volt.